

P-Channel MOSFET

FR9024N (KFR9024N)

■ Features

- $V_{DS} (V) = -55V$
- $I_D = -11 A (V_{GS} = -10V)$
- $R_{DS(ON)} < 175m\Omega (V_{GS} = -10V)$
- Fast Switching
- Fully Avalanche Rated

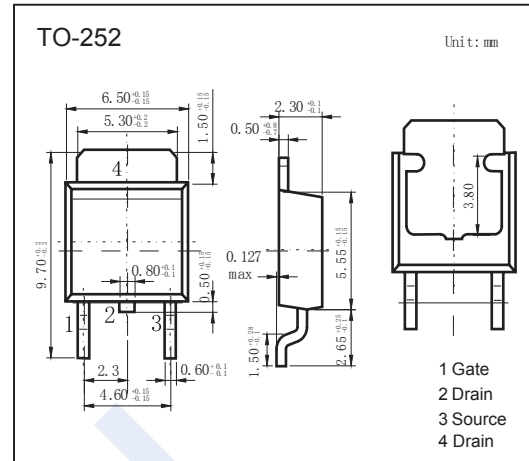
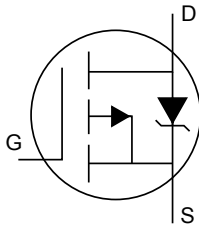

■ Absolute Maximum Ratings $T_a = 25^\circ C$

Parameter	Symbol	Rating	Unit
Drain-Source Voltage	V_{DS}	-55	V
Gate-Source Voltage	V_{GS}	± 20	
Continuous Drain Current	I_D	$T_c = 25^\circ C$	A
		$T_c = 100^\circ C$	
Pulsed Drain Current	I_{DM}	-44	
Avalanche Current	I_{AR}	-6.6	
Power Dissipation	P_D	38	W
Single Pulse Avalanche Energy (Note.1)	E_{AS}	62	mJ
Repetitive Avalanche Energy	E_{AR}	3.8	
Peak Diode Recovery dv/dt (Note.2)	dv/dt	-10	V/ns
Thermal Resistance.Junction- to-Ambient (PCB mount)	R_{thJA}	50	$^\circ C/W$
Thermal Resistance.Junction- to-Ambient		110	
Thermal Resistance.Junction- to-Case		R_{thJC}	
Junction Temperature	T_J	150	$^\circ C$
Junction Storage Temperature Range	T_{stg}	-55 to 150	

Note.1: Starting $T_J = 25^\circ C$, $L = 2.8mH$, $R_G = 25\Omega$, $I_{AS} = -6.6A$.

Note.2: $I_{SD} \leq -6.6A$, $di/dt \leq 240A/\mu s$, $V_{DD} \leq V_{(BR)DSS}$, $T_J \leq 150^\circ C$

P-Channel MOSFET

FR9024N (KFR9024N)

■ Electrical Characteristics Ta = 25°C

Parameter	Symbol	Test Conditions	Min	Typ	Max	Unit
Drain-Source Breakdown Voltage	V _{DSS}	I _D =-250 μA, V _{GS} =0V	-55			V
Zero Gate Voltage Drain Current	I _{DSS}	V _{DS} =-55V, V _{GS} =0V			-25	μA
		V _{DS} =-44V, V _{GS} =0V, T _J =150°C			-250	
Gate-Body leakage current	I _{GSS}	V _{DS} =0V, V _{GS} =±20V			±100	nA
Gate Threshold Voltage	V _{GS(th)}	V _{DS} =V _{GS} I _D =-250 μA	-2		-4	V
Static Drain-Source On-Resistance	R _{DS(on)}	V _{GS} =-10V, I _D =-6.6A			175	mΩ
Forward Transconductance	g _{FS}	V _{DS} =-25V, I _D =-7.2A	2.5			S
Input Capacitance	C _{iss}	V _{GS} =0V, V _{DS} =-25V, f=1MHz		350		pF
Output Capacitance	C _{oss}			170		
Reverse Transfer Capacitance	C _{rss}			92		
Total Gate Charge	Q _g	V _{GS} =-10V, V _{DS} =-44V, I _D =-7.2A (Note.1)			19	nC
Gate Source Charge	Q _{gs}				5.1	
Gate Drain Charge	Q _{gd}				10	
Internal Drain Inductance	L _D	Between lead, 6mm (0.25in.) from package and center of die contact		4.5		nH
Internal Source Inductance	L _S			7.5		
Turn-On DelayTime	t _{d(on)}	V _{DS} =-28V, I _D =-7.2A, R _G =24Ω, R _D =3.7Ω (Note.1)		13		ns
Turn-On Rise Time	t _r			55		
Turn-Off DelayTime	t _{d(off)}			23		
Turn-Off Fall Time	t _f			37		
Body Diode Reverse Recovery Time	t _{rr}	I _F =-7.2A, di/dt=100A/μs, T _J =25°C,		47	71	nC
Body Diode Reverse Recovery Charge	Q _{rr}			84	130	
Maximum Body-Diode Continuous Current	I _S				-11	A
Pulsed Source Current	I _{SM}				-44	
Diode Forward Voltage	V _{SD}	I _S =-7.2 A, V _{GS} =0V, T _J =25°C, (Note.1)			-1.6	V

Note.1: Pulse width ≤ 300μs; duty cycle ≤ 2%.

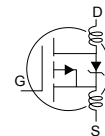

P-Channel MOSFET FR9024N (KFR9024N)

■ Typical Characteristics

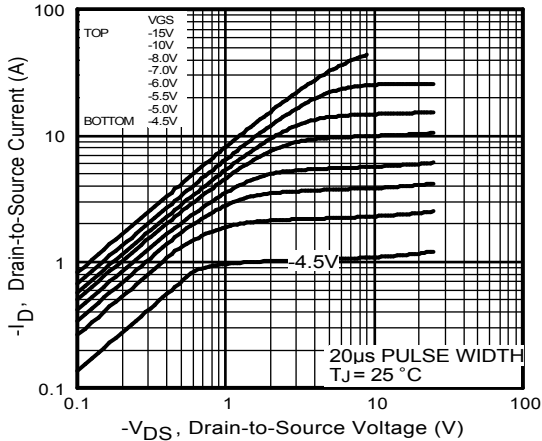

Fig 1. Typical Output Characteristics

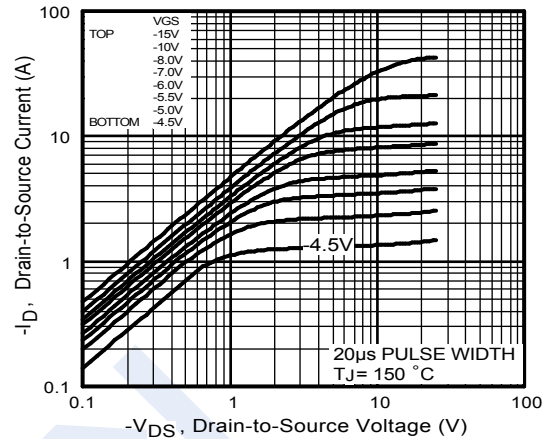

Fig 2. Typical Output Characteristics

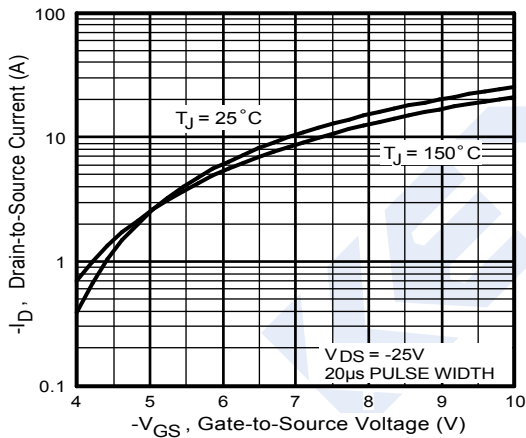

Fig 3. Typical Transfer Characteristics

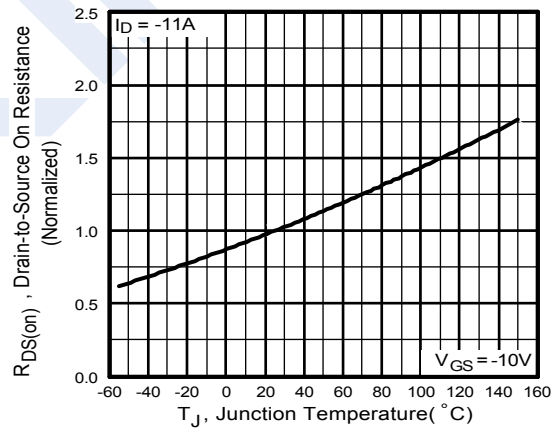

Fig 4. Normalized On-Resistance Vs. Temperature

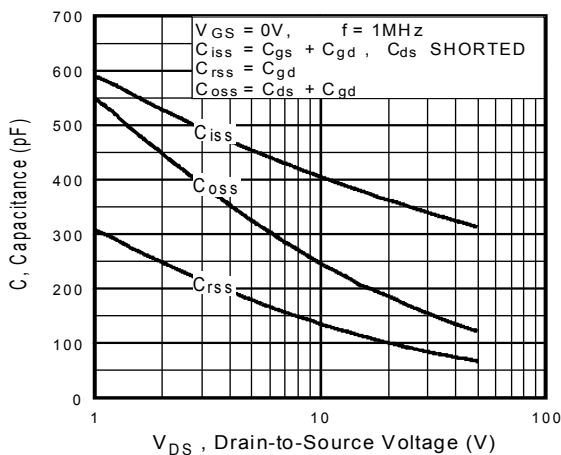

Fig 5. Typical Capacitance Vs. Drain-to-Source Voltage

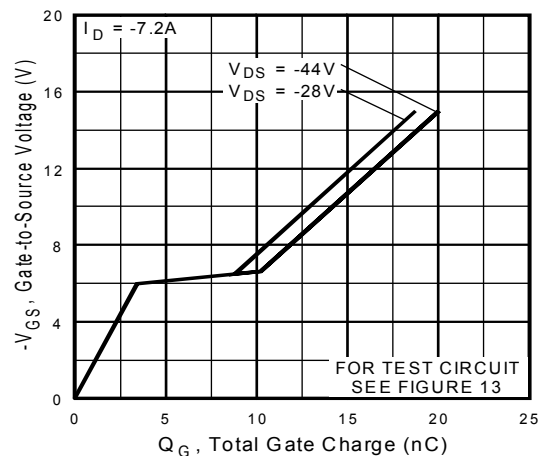

Fig 6. Typical Gate Charge Vs. Gate-to-Source Voltage

P-Channel MOSFET FR9024N (KFR9024N)

■ Typical Characteristics

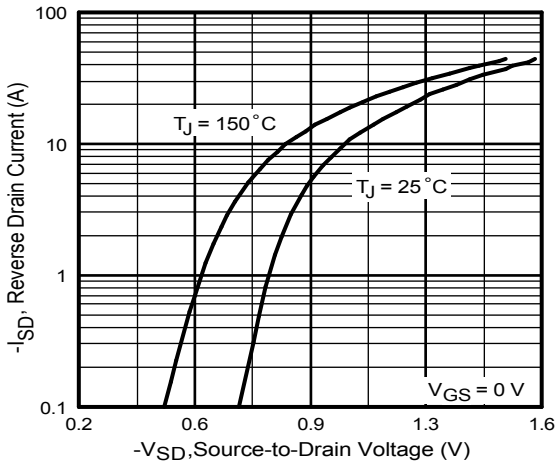

Fig 7. Typical Source-Drain Diode Forward Voltage

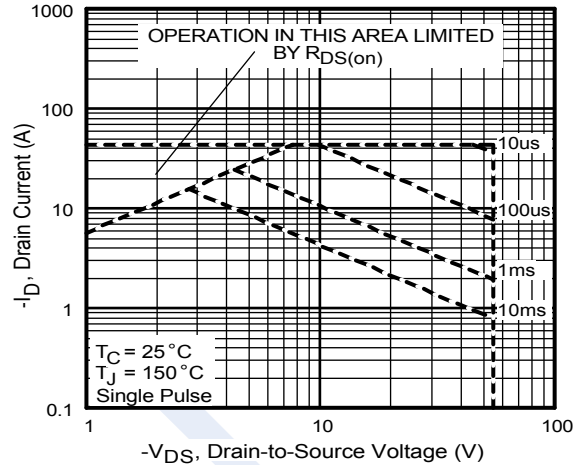

Fig 8. Maximum Safe Operating Area

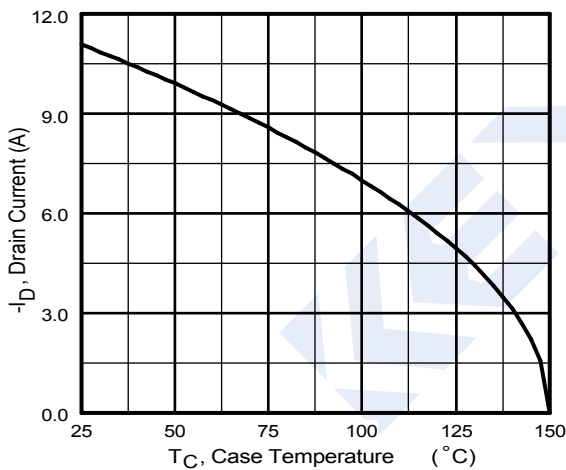

Fig 9. Maximum Drain Current Vs. Case Temperature

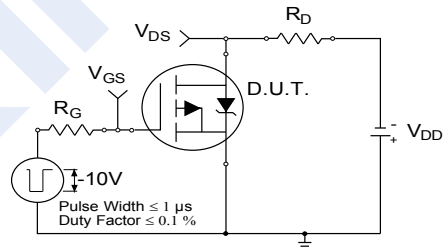

Fig 10a. Switching Time Test Circuit

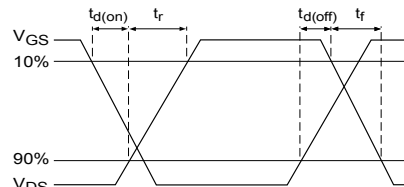

Fig 10b. Switching Time Waveforms

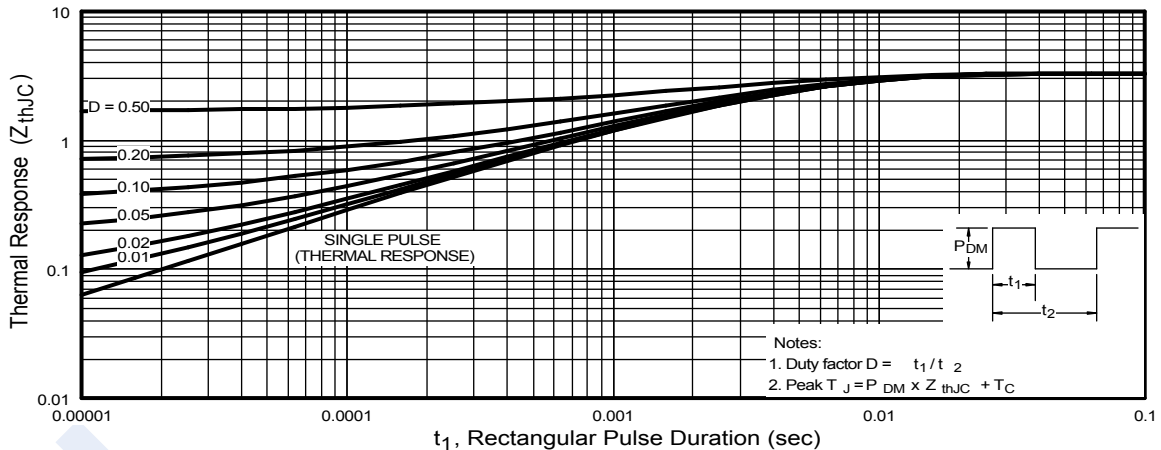

Fig 11. Maximum Effective Transient Thermal Impedance, Junction-to-Case

P-Channel MOSFET FR9024N (KFR9024N)

■ Typical Characteristics

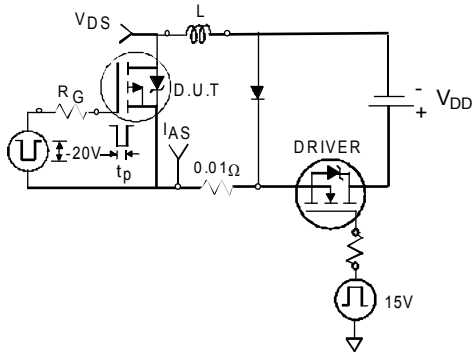

Fig 12a. Unclamped Inductive Test Circuit

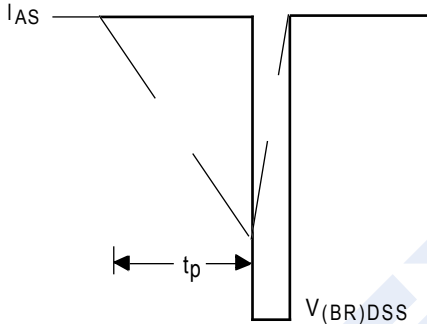

Fig 12b. Unclamped Inductive Waveforms

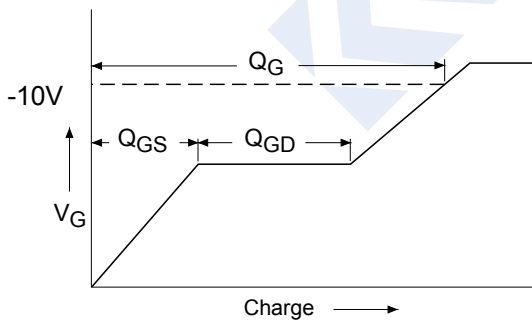

Fig 13a. Basic Gate Charge Waveform

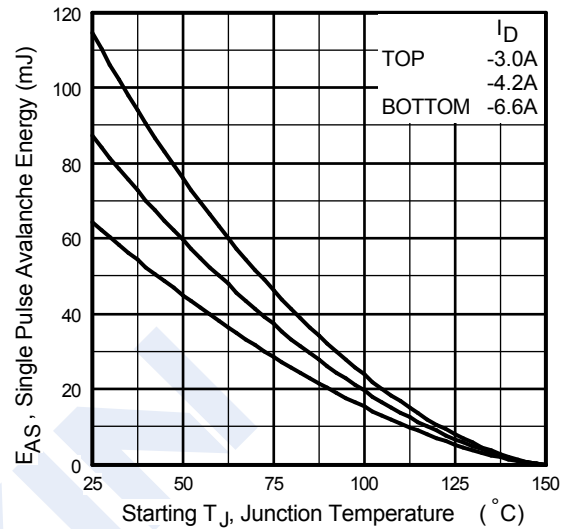

Fig 12c. Maximum Avalanche Energy Vs. Drain Current

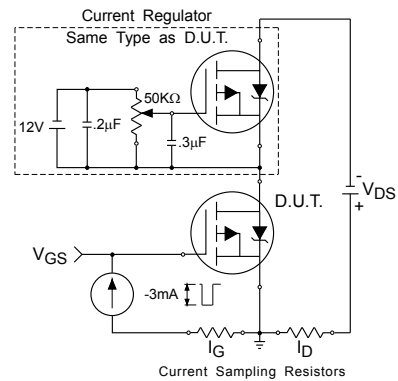
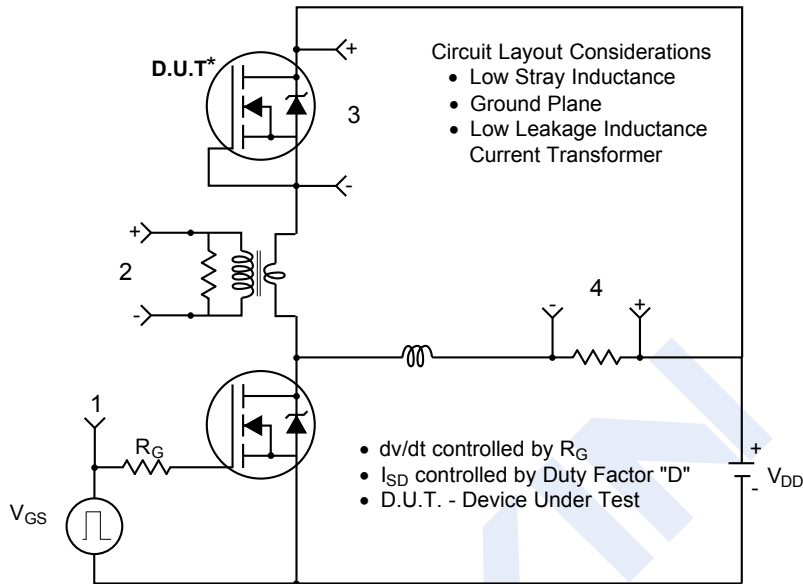

Fig 13b. Gate Charge Test Circuit

P-Channel MOSFET FR9024N (KFR9024N)

■ Typical Characteristics

Peak Diode Recovery dv/dt Test Circuit



* Reverse Polarity of D.U.T for P-Channel

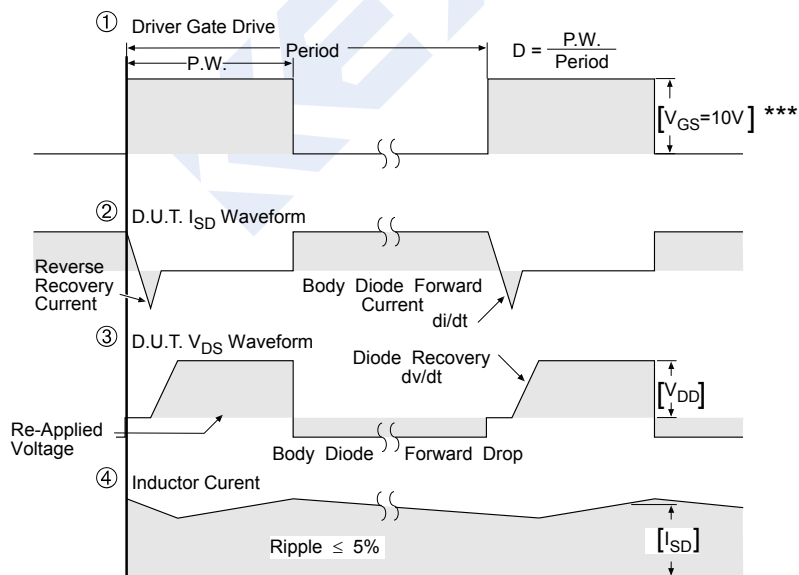

*** $V_{GS} = 5.0V$ for Logic Level and 3V Drive Devices

Fig 14. For P-Channel HEXFETS